

PES1065G

10.0AMPS.SIC SCHOTTKY BARRIER DIODE

FEATURE

- . 650V Schottky Diode
- . Zero Reverse Recovery/Zero Forward Recovery
- . High Efficiency Operation
- . Extremely Fast Switching
- . Temperature Independent Switching Behavior

TYPICAL APPLICATIONS

- . Switch mode power supply
- . Power factor correction Solar Invertor
- . Solar inverter
- . Uninterruptible power supply

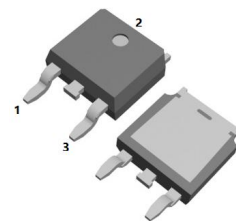

TO-252-2L



MAXIMUM RATINGS (T_C=25°C unless otherwise noted)

Parameter	Symbol	PES1065G	Units
Maximum Recurrent Peak Reverse Voltage	V_{RRM}	650	V
Maximum RMS Voltage	V_{RMS}	455	V
Maximum DC blocking Voltage	V_{DC}	650	V
Maximum Average Forward Rectified Current at T _C =150°C	$I_{F(AV)}$	10	A
Non-Repetitive Peak Forward Surge Current T _c =25°C, t _p =8.3 ms, Half Sine Pulse	I_{FSM}	86	A
Total power dissipation T _c =25°C	P_D	71	W
Operation Junction Temperature and Storage Temperature	T_J, T_{STG}	-55 to +175	°C

ELECTRICAL CHARACTERISTICS (T_C=25°C unless otherwise noted)

Parameter	Symbol	Typ	Max	Units	
Forward voltage	V_F	I _F =10A, T _j =25°C	1.27	1.5	V
		I _F =10A, T _j =175°C	1.38	1.6	
Reverse current	I_R	V _R =650V, T _j =25°C	6	50	μA
		V _R =650V, T _j =175°C	25	200	
Total capacitive charge	Q_c	25	---	nC	
Total capacitance	C	V _R =0V, T _j =25°C, f=1MHZ	640	---	pF
		V _R =200V, T _j =25°C, f=1MHZ	66	---	
		V _R =400V, T _j =25°C, f=1MHZ	48	---	

THERMAL CHARACTERISTICS (T_C=25°C unless otherwise noted)

Parameter	Symbol	Typ	Max	Units
Typical Thermal Resistance Junction to Case	$R_{(JC)}$	2.1	----	°C/W

RATING AND CHARACTERISTIC CURVES

FIG.1-FORWARD CHARACTERISTICS

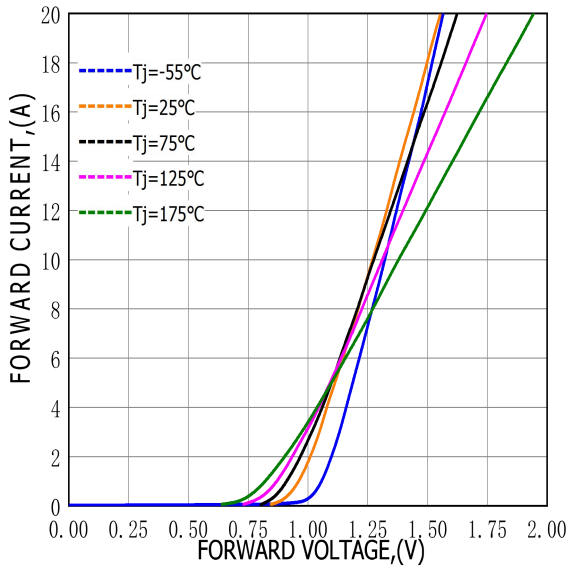

FIG.2-REVERSE CHARACTERISTICS

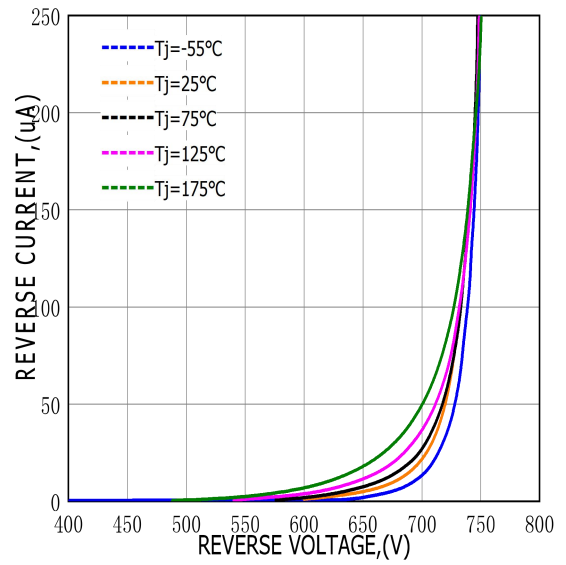

FIG.3-TOTAL CAPACITANCE CHARGE VS REVERSE VOLTAGE

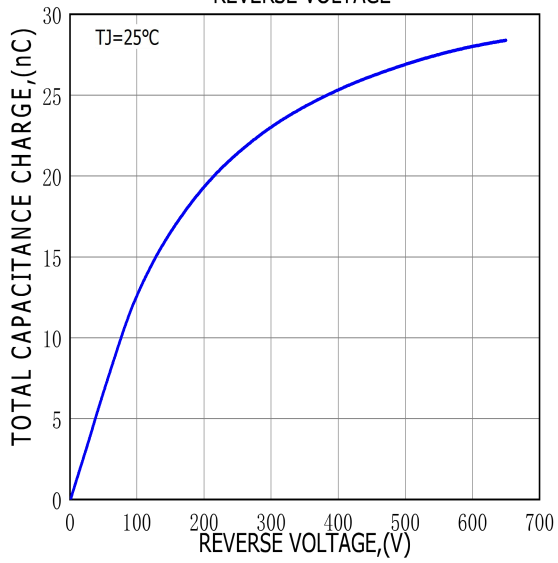
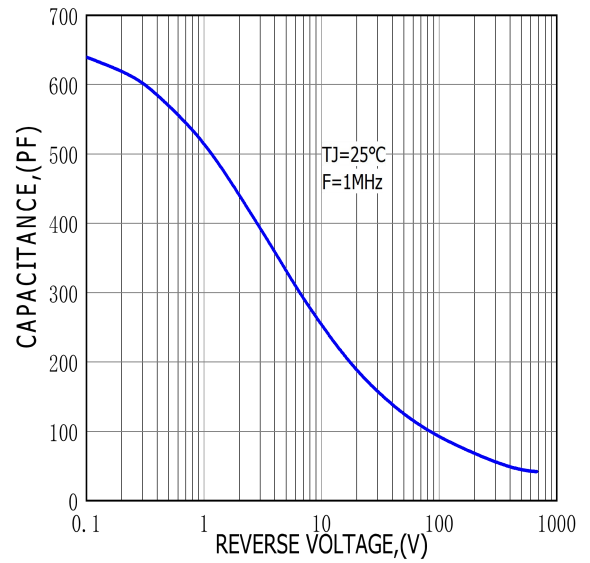
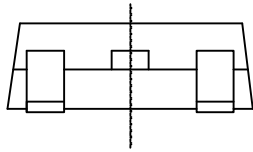
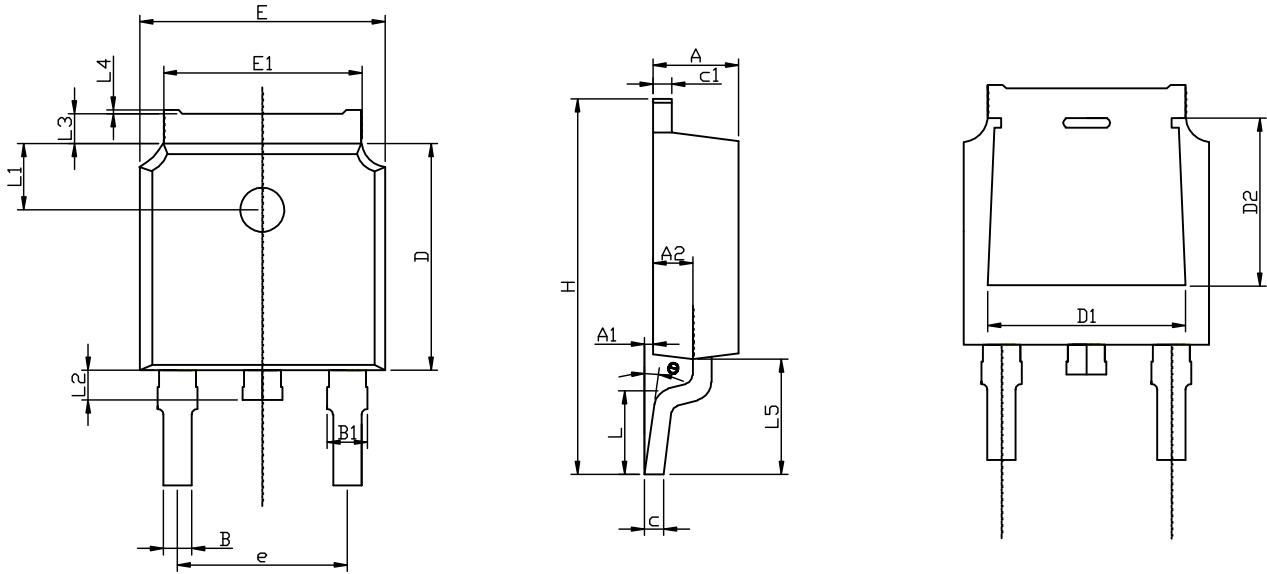

FIG.4-CAPACITANCE VS REVERSE VOLTAGE



TO-252-2L PACKAGE OUTLINE



RECOMMENDED LAND PATTERN

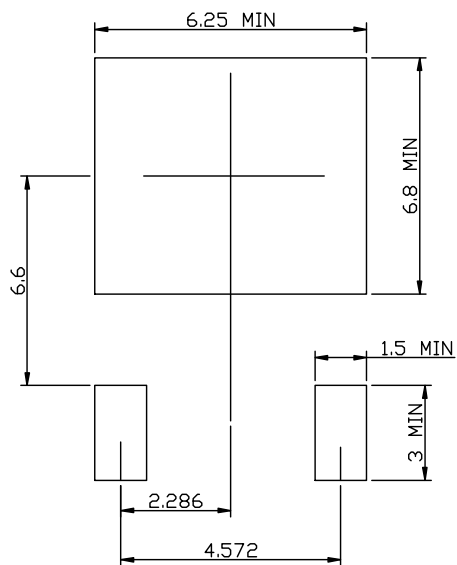

	MIN	NOM	MAX
A	2.15	2.30	2.45
A1	0.05	0.10	0.20
A2	0.91	1.07	1.22
B	0.66	0.76	0.86
B1	0.93	1.08	1.23
C	0.40	0.50	0.60
C1	0.40	0.50	0.60
D	5.95	6.10	6.25
D1	-	4.8REF	-
D2	-	3.8REF	-
E	6.45	6.60	6.75
E1	5.12	5.32	5.52
L		1.65	
L1	1.58	1.78	1.98
L2	0.60	0.80	1.00
L3	0.70	0.85	1.00
L4	0.00	0.05	0.20
L5	2.80	3.10	3.40
H	9.80	10.10	10.40
Θ	0°		8°
e		4.572REF	

UNIT: mm